

User Manual



RISH *Multi* 12S ... 16S

Analog-Digital Multimeter



RISHABH INSTRUMENTS PVT. LTD.

Factory :

F-31 MIDC, Satpur, Nashik-422 007 India.
Phone : (+91 253) 351062, 351063, 353063, 353064
Fax : +91 253 351064
E-mail address : rishabh@bom2.vsnl.net.in

Mumbai Office :

A-54, MIDC, Marol Ind. Estate,
Andheri (East), Mumbai - 400 093.
Phone: (+91 22) 6921425/26
Fax : +91 22 6921427



RISHABH
08/2001

Printed in India. Subject to change without Notice

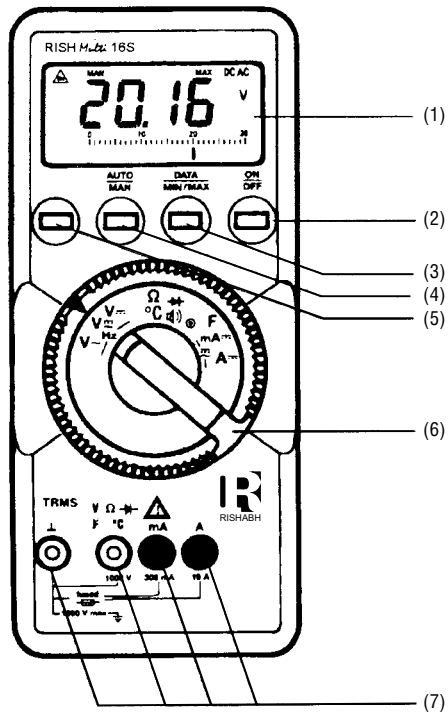

19. Servicing
When you need service, please contact:

Rishabh Instruments Pvt. Ltd.
F-31, M.I.D.C., Satpur,
Nashik - 422 007
Maharashtra
India

Telephone : (0253) 351062, 351063, 353063
Telefax : (0253) 351064
E-mail : rishabh@bom2.vsnl.net.in

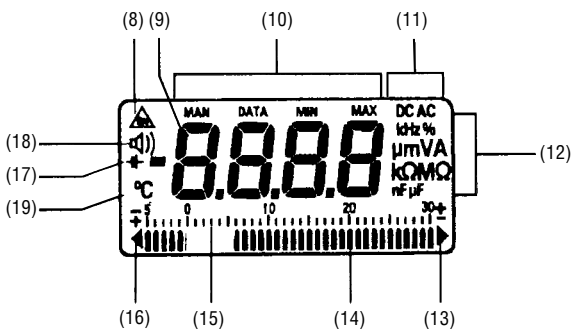

Voltage measurement

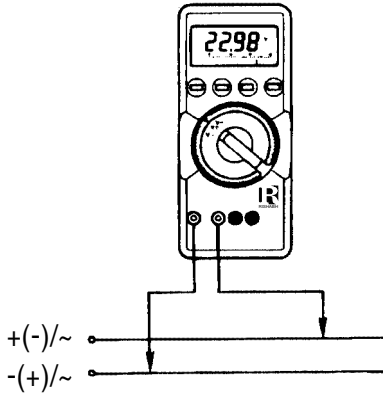

Resistance measurement

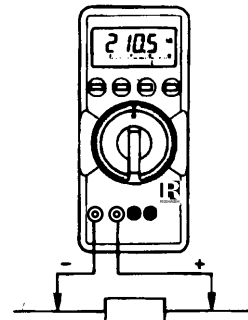

Diode Test

Forward direction Reverse direction

Voltage measurement on electrical systems up to 1000 V with the KS30 measuring adapter

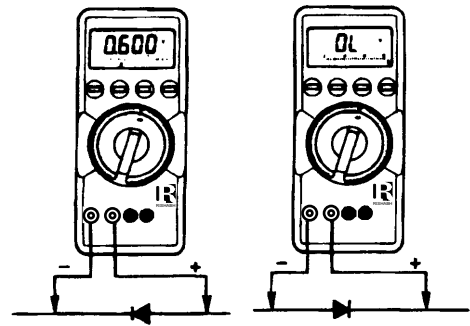
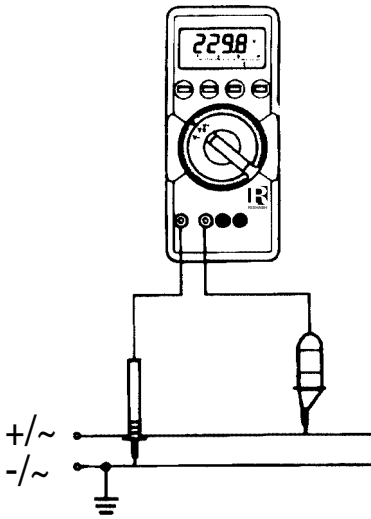

Continuity Test

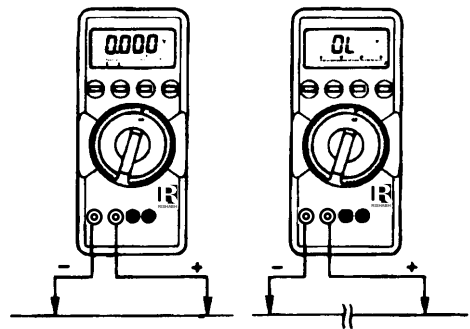

Current measurement

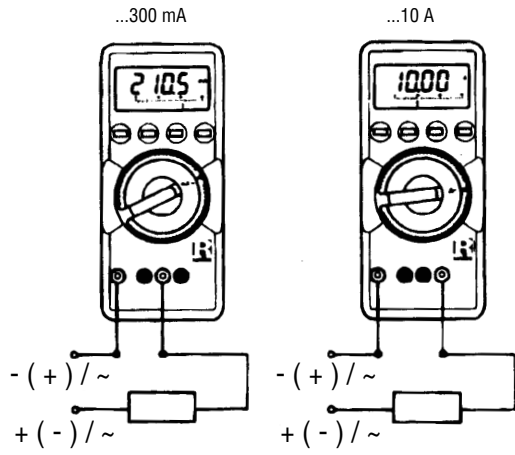

AC current measurement with (clip-on) current transformers

